

# N34 (Pisa)

## Naturstein klassisch



Abbildung:  
Naturstein Rosa Crema

Standard-  
Ausführung



Tür  
hochschiebbar



Front Kristall

Gesamt-  
gewicht



ca. 420 kg

Kamineinsatz

Lina 7363 h  
NW-Leistung: 9 kW



www.Schmid.st

Individuelle  
Frontausführung



Front  
Anthrazit



Front Kristall +  
(außer Lina W)



Front veredelt  
VAG



Doppel-  
verglasung

Front Deco  
und komplett  
veredelt auf  
Anfrage

Zubehör



Kesselgerät  
Lina W



Heizwasser-  
Aufsatzregister



Aufsatz-  
speicher



Warmluft-  
Aufsatzregister



Nachheiz-  
kasten



Schmid  
Multi-Regelung



Elektronischer  
Türantrieb



Vorlegeplatte

Naturstein



Blanco Carrara



Blanco Macael

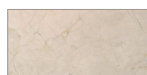

Crema Marfil

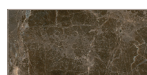

Marron Emp.



Negro Abanilla



Rojo Alicante

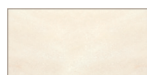

Rosa Claro

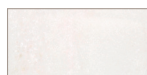

Rosa Crema



Arenisca S. M.

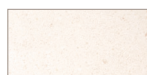

Blanco Nac.



Caliza Moka



Travertino Rom.

Symbolerklärung unter  
[www.camina.de/  
gestaltungsvarianten.html](http://www.camina.de/gestaltungsvarianten.html)

### Frontansicht M 1:25

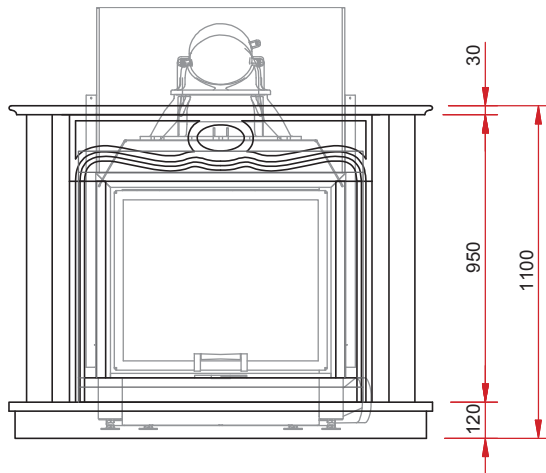

### Seitenansicht M 1:25

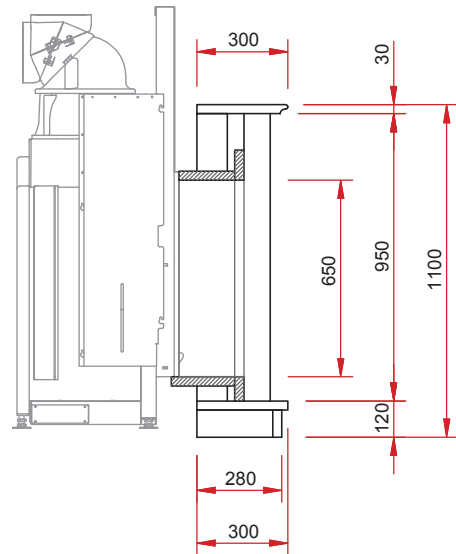

### Draufsicht M 1:25

